

Engine

Cummins QSB 4.5, EU Stage IV

Net Power

114 hp (84 kW)

Operating Weight

15,150 – 16,300 kg (33,400 – 35,935 lbs)

Bucket Capacity

0.36 – 0.77 m³ (0.47 - 1.01 yd³)

915E

EXCAVATOR



TOUGH WORLD. TOUGH EQUIPMENT.

TOUGH WORLD. TOUGH EQUIPMENT.

You don't need to be told it's a tough world. It's your reality, you live it every day and you know how hard it can be on your people and your machines. It's getting tougher to make your business pay too, with rising costs, increasing legislation and greater competition. We understand and we've put that understanding into action with our new 915E.

915E. NO TOUGH COMPROMISES, JUST EVERYTHING YOU NEED AND NOTHING YOU DON'T

The construction equipment industry has seen an expensive trend towards over-engineered products. Some manufacturers genuinely believe that adding cost, adds perceived value in customers' eyes.

BUT YOU TOLD US A DIFFERENT STORY

You asked for a tough, well-engineered excavator, which can do the job. Any job.

YOU WANTED AN EXCAVATOR THAT DELIVERS ON 3 ESSENTIAL NEEDS :

1



FIT FOR PURPOSE

2



UPTIME AND SUPPORT

3



TOTAL COST OF OWNERSHIP



With the 915E, we've met your challenge and given you everything you want – without compromise.



TOUGH FACTS

TOUGH QUALITY STANDARDS

When it comes to quality, we let our actions to speak for themselves.

We are following a rigorous Six Sigma methodology and consistently achieve ISO 9001 standards.

TOUGH RESEARCH AND TESTING

Finding tougher, smarter, safer and more cost-effective ways of working matters to you. It matters to us too. Our new Global Research & Development Centre in Liuzhou China, is a great example of this customer focused approach. We've established an international team of industry experts, backed up with the latest world-class technology, all focused on delivering greater value to you.

TOUGH PARTNERS

LiuGong has teamed up with some of the industry's best known names. Here's just a few of our valued joint venture partners;

- German drivetrain components manufacturer ZF Friedrichshafen AG
- Finnish mining and aggregates processing equipment manufacturer Metso
- North American diesel engine manufacturer Cummins

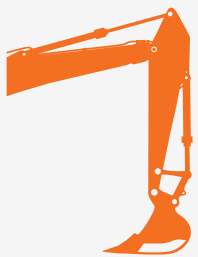

FIT FOR PURPOSE

Firstly, you need to know that your machine is up to the job; breaking, digging, lifting, working hard – anytime – anywhere. Excavators have got to be tough and they've got to perform.

OUR NEW 915E HIGH PERFORMANCE FROM THE GROUND UP

1 TOUGHER UNDERCARRIAGE

With X-shaped frame built from high strength tensile steel, the 915E's undercarriage is designed to withstand the toughest conditions. Continuous digging, lifting and loading can put excessive stress on machines. The 915E has a long track beam and crawler system that guarantees greater stability. The structure also helps protect key components such as the travel motor from undue stress.

2 TOUGHER UPPER STRUCTURE

The upper structure of the 915E is built around a reinforced and well-engineered H-beam, allowing the boom to be mounted exactly in the center of the machine. This central positioning helps the boom cope with more stress on the attachment group. It also means better distribution of weight and tension along the entire machine.

3 SAFER CAB

Our cabs are designed to protect your most important asset. Your operator. ROPS (Roll Over Protection System) and FOPS (Falling Object Protection System) safeguard your most important asset: your operator in the toughest environment. Visibility is key to protecting your operator and workers on site. The large glass surface area, increased by 15% on the E-series cab compared with our previous model, combined with the rear-view camera, provides an extraordinary view of the 915E's surroundings.

4 TOUGHER BOOM AND ARM

The 915E features a tougher, reinforced heavy duty boom and arm built from high-strength tensile steel, with castings and forgings in high stress areas for heavy-duty performance and maximum uptime. We also use over-sized pins to allow the 915E, not just to work harder, but to work harder for longer. Our confidence in our machines is underlined by one of the most comprehensive warranties in the industry.

5 INCREASED VERSATILITY WITH BLADE

The optional dozer blade speeds up site cleanup, helps to trap objects against the blade for easier bucket loading. It also means, you can make maximum use of breakout force and lifting performance thanks to increased stability.



6 MULTIFUNCTIONAL

Switching attachments like buckets, breakers and shears can be time consuming. We've made it fast, safe and simple with LiuGong's quick coupler and tilt coupler. These are perfectly matched to a range of genuine LiuGong attachments which can be changed from the seat of the cab in less than a minute, quick, safe and easy.

7 DO THE JOB RIGHT

Six selectable work modes equip even the newest operator with the skills of an expert, allowing them to perfectly match machine performance with the job, whatever that job may be.



Power



Economy



Fine



Lifting



Breaker



Attachment

8 FASTER CYCLE TIMES

Greater hydraulic flow and higher swing speeds combine to improve cycle times by 12% on tasks such as truck loading, digging, trenching and backfilling compared with our previous model.



JOBSITE FACT: ANYTIME



Over 10,000 hours registered and still working hard.

Tapegyseg Co. Hungary

"We use our LiuGong excavator for breaking down large stone and concrete sections. In two years we have not had a problem and our machines are working 10-11 hours a day, six days a week."

JOBSITE FACT: ANYWHERE!



-49°C

Temperatures drop but the work rate stays high.

LiuGong Excavators played a key part in supporting China's Polar Exploration team. Extreme temperatures, high altitudes, strong winds and intense ultraviolet light made the Antarctic an extremely tough test environment.

TOUGH JUDGES

Operators are tough judges. They know what they like and what they don't. We've talked, we've listened and we've delivered a no-nonsense excavator that will do everything the operator wants and needs it to do. Job done? Judge for yourself.

TOUGH EQUIPMENT
50,000 Excavators currently in the field.
 Over **1/2 BILLION** productive hours worked.



EFFICIENCY, PRECISION & VERSATILITY

Fit for purpose is about giving your operators efficient and intelligent power when they need it, with control and precision. That's what we do.

POWER WITHOUT COMPROMISE.

The 915E is powered by the latest Cummins QSB 4.5 engine with a rated net power of 114 hp (84 kW) @ 2,200 rpm in compliance with EU Stage IV emission standards.

The compact QSB 4.5 delivers unmatched and dependable power in its class yet it minimizes emissions.

The engine utilizes a precise and high pressure common-rail fuel injection system, turbo charger (VGT) and air-to-air intercooler along with electronic engine controls to optimize machine performance. It's powerful. It's responsive. It tackles the toughest jobs without being thirsty for fuel.

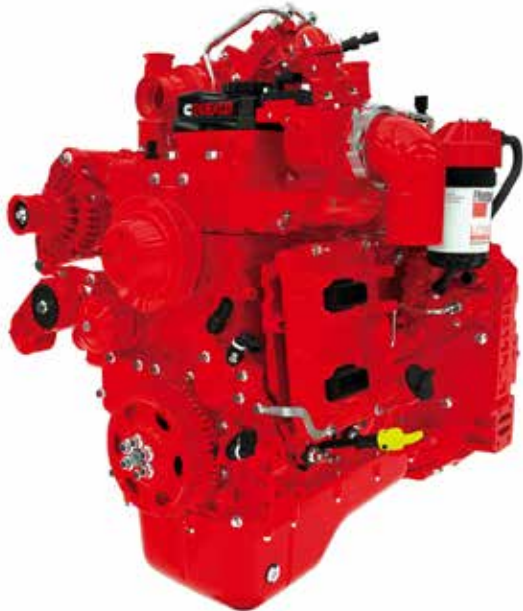

INTELLIGENT POWER CONTROL

The 915E's advanced Intelligent Power Control (IPC) system intelligently delivers the power you need – when you need it.

This new generation computer-aided IPC system allows the 915E's mechanical, electrical and hydraulic systems to work together in perfect harmony and helps even novice operators get more from the machine. An improved pump system delivers efficient oil output under lower engine speeds, resulting in fuel efficiency and reduced noise levels.

ADVANCED HYDRAULIC SYSTEM

LiuGong's advanced hydraulic system, regenerates oil from the cylinders more efficiently reducing heat, increasing fuel efficiency and improving cycle times.

The hydraulic system is highly effective in delivering power and precise control to where the operator really needs it, making even the toughest job simple.



SMART FUEL ECONOMY

The intelligent combination of powerful digging force, swing torque and lifting performance make the most of every drop of fuel. The 915E maximizes fuel economy by intelligently regulating its idle speed by the second.



1 second: If no hydraulic request signal detected from the joystick, the engine speed is automatically dropped by 100 RPM.



3 seconds: If no activity is detected over three seconds the engine speed will decrease to idle. In each case, as soon as the system detects the hydraulic signal once more, the engine will immediately return to the previous throttle speed setting.

DAILY CHECKS AND MAINTENANCE SHOULDN'T BE TOUGH

Simple daily checks and maintenance prolong machine performance but, they can be difficult and time consuming on tough jobsites where time is precious. **Not with the 915E.**

If servicing is easy, it gets done. In 915E, smart and effective design makes service and maintenance fast and simple – that's good news for operators who work in some of the toughest places on the planet.

Daily maintenance items like greasing points are easy to reach from ground level. Filters and components are conveniently positioned and there is ample space in the hydraulic pump & filter compartment.

Handrails are fitted as standard on the 915E, enabling safe and easy access to the upper structure for easy engine service and maintenance.

Thanks to all, the 915E is easy to maintain and look after. It's designed to maximize uptime and deliver to your bottom line.

EASILY ACCESSIBLE SERVICE POINTS MAKE DAILY CHECKS FAST AND EFFECTIVE

- Easily visible hydraulic oil level gauge
- Accessible, grouped filters
- Easy to replace A/C filter next to the cab door
- Maintenance free air filter

ONBOARD MONITORING

With onboard monitoring, the operator can check the machine's vital signs without leaving his seat.

Using the LCD display, the operator can easily check oil temperatures and pressure levels, receive service interval alerts and access other information that contributes to simple maintenance and servicing of the machine.





COMFORT AND SAFETY. NO COMPROMISES

Climb into the cab of the 915E and you can see that it has been designed by someone who has operated a machine in really tough conditions.

For a start, it's safe and easy to get in and out of.

Trips and slips account for the majority of accidents onsite. Well-placed door handles, safety rails and anti-slip tape on the upper part of the machine make it easier and safer for operators to enter and exit the cab in all weathers and conditions.

Inside, the cab is secure and protected with space to work and excellent 360 degree views of the site.

The controls are where the operator needs them to be. They are easy to see, easy to reach and easy to handle.

The multi-adjustable air-suspension seats are comfortable and designed to keep the operator fresh and alert.

The cab is sound proofed, vibration protected and well ventilated. It has advanced climate control to handle the changing seasons and is completely sealed to prevent dust contamination.

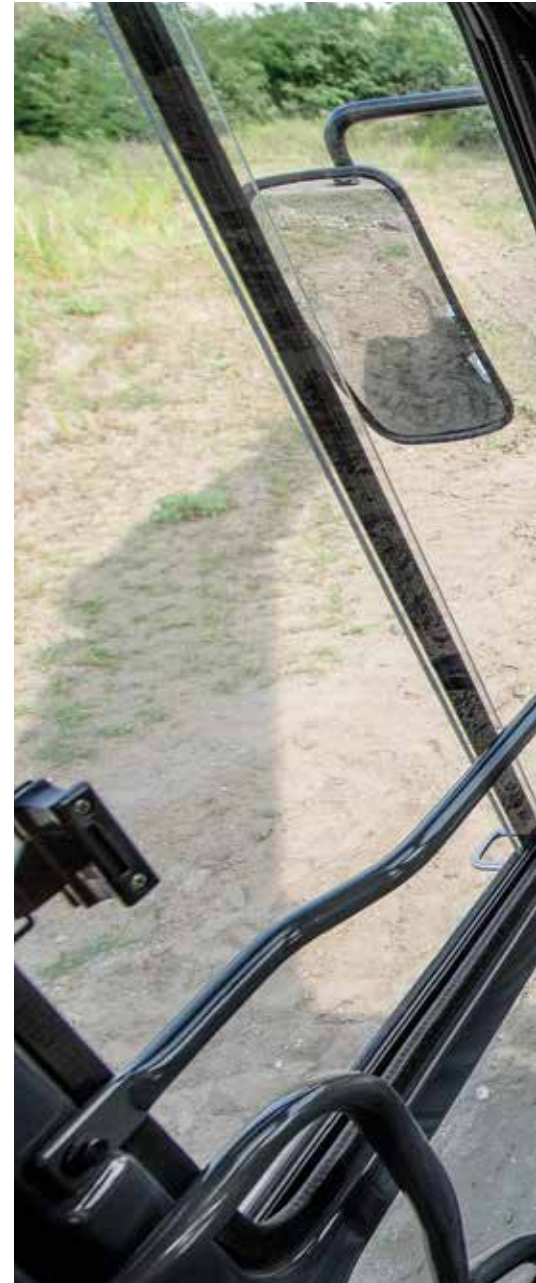

WE PUT OPERATORS FIRST

It makes good business sense to give operators the very best working environment – a comfortable operator is a productive operator. The 915E keeps operators safe, more alert and more productive.

Smart additions such as; rear view camera, heated seats, refrigerator or personal belonging compartment and an iPod/AUX connection combine to create the best environment – for the best operators.



ADVANCED CLIMATE CONTROL

An advanced climate control system creates the right environment in any weather.

LARGE LCD MONITOR

The easy-to-read, full-color LCD monitor displays all the critical information your operator needs, including working mode, hydraulic oil temperature, hydraulic pressure and service intervals.





JOBSITE UPTIME AND SUPPORT

Fit for purpose might convince you to buy your first machine, but it's uptime and support and total cost of ownership which will keep you coming back to buy more machines. Having confidence in the machine's back up and support network is a vital part of the purchasing decision. How do we at LiuGong measure up?

FAST RESPONDING GLOBAL NETWORK

We have an extensive dealer network of over 300 dealers in more than 100 countries.

All supported by 10 regional subsidiaries and 9 global parts centers offering expert training, parts and service support.



WE ARE LIUGONG. WORKING HARD TO KEEP OUR GLOBAL CUSTOMERS EARNING

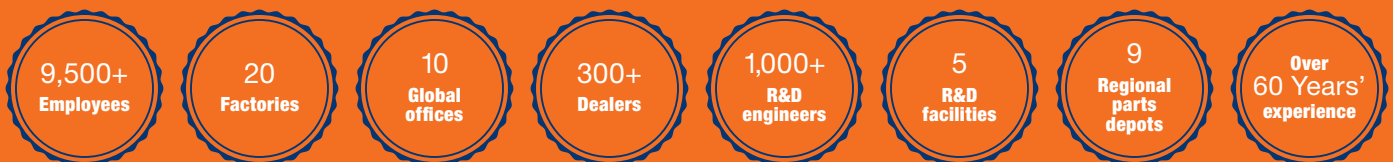

WHERE YOU NEED US WHEN YOU NEED US

Reliability is built into our machines but all machines have some planned downtime. Our aim is to reduce even planned down time to the minimum by getting it right.

Technician training and parts availability are also high on our agenda, as is keeping you

informed on service and maintenance work and providing clear and accurate estimates, invoices and communication.

These may be small things, but customer feedback tells us that these basics really matter – so we aim to get them right.

MAINTENANCE AND SUPPORT PACKAGES

From genuine LiuGong parts, to full repair and maintenance contracts, LiuGong has the flexibility to offer the level of support and response to suit your business and applications. Whatever level of support you choose you can be confident that it is backed up by LiuGong's service promise.



**Right parts.
Right price.
Right service.**

**Above all,
we get it right
the first time.**

1st



LIUGONG SERVICE PROMISE



Highly trained technicians
utilizing the latest
diagnostic equipment



15,000+ Genuine LiuGong
parts available within 24hrs
from our European Parts
Distribution Center



Multi-lingual service helpline
and online support



Transparent estimates
and invoicing



Clear communications through
electronic parts catalogue



TOTAL COST OF OWNERSHIP

Fit for purpose and uptime & support are two key excavator purchasing criteria but ultimately, the machines earning potential, its overall life cost and its trade-in value really matter too.

When it comes to total cost of ownership LiuGong has a strong story to tell.

PROFESSIONAL ADVICE

We are committed to reducing your total cost of ownership and increasing your profits. As part of this, LiuGong's experts will provide targeted advice on everything, from choosing the right machine for your needs to maximizing its efficiency on site.

MACHINE AVAILABILITY

Our machines deliver everything you need and nothing you don't. They are expertly engineered NOT over engineered. As a result of having an extensive manufacturing operation right in the heart of Europe, we can offer significantly shorter lead times on

a range of models, compared with some manufacturers. In fact, we can deliver selected machines in as little as 4 weeks.

The faster you can get a machine – the faster you can get working and earning. Our aim is to get you on to the jobsite fast.

TICKET PRICE

At LiuGong, our aim is to provide you with real, measurable value by giving you everything you need and nothing you don't. For example, we choose high quality, proven components such as Cummins engines and Kawasaki hydraulic pumps. These proven components, combined with LiuGong design and manufacturing quality, result in a high quality, competitive machine that is totally fit for purpose.

RESIDUAL VALUE

With the combination of LiuGong design and manufacturing excellence, world class components and comprehensive uptime support, our quality holds its value.





IT ALL ADDS UP

With the 915E we've risen to the challenge and given you everything you need and nothing you don't.

It's an excavator which can handle any job, anywhere, backed up by LiuGong's service promise and designed to perform on the jobsite and on the balance sheet. Add up the benefits and you'll see that 915E represents the formula for success.



FIT FOR PURPOSE

+

**UPTIME AND
SUPPORT**

+

**TOTAL COST
OF OWNERSHIP**

CUSTOMER SATISFACTION

SPECIFICATIONS

Operating weight

- without blade	15,150 kg (33,400 lbs)
- with blade	16,300 kg (35,935 lbs)

Operating weight includes coolant, lubricants, full fuel tank, cab, standard shoes, boom, arm, bucket and operator 75 kg (165 lbs).

Bucket capacity	0.36 – 0.77 m ³ (0.47 - 1.01 yd ³)
-----------------	--

ENGINE

Description

Cummins EU Stage IV, 4-cylinder straight Variable-Geometry Turbocharger (VGT), high pressure common rail, electronically controlled direct injection. Air cleaner: Cummins direct flow air filter. Cooling system: Charge air cooler.

Emission rating	EU Stage IV
Engine manufacturer	Cummins
Engine model	QSB 4.5
Aspiration	Variable-Geometry Turbocharger (VGT)
Charged air cooling	Aftercooler
Cooling fan drive	Viscous clutch
Displacement	4.5 L (1.19 gal) 4,500 cm ³ (275 in ³)
Rated speed	2,200 rpm
Engine output - net (SAE J1349 / ISO 9249)	84.3 kW (114 hp)
Engine output - gross (SAE J1995 / ISO 14396)	90 kW (122 hp)
Maximum torque	470 N·m (347 lbf·ft) @1,500 rpm
Bore × Stroke	107 × 124 mm (4.2" × 4.9")

DRIVE AND BRAKES

Description

2-speed axial piston motors with oil disk brakes. Steering controlled by two hand levers with pedals.

Max. travel speed	High: 6.0 km/h (3.7 mph) Low: 3.5 km/h (2.2 mph)
Gradeability	35%/70%
Max. drawbar pull	124 kN (27,876 lbf)

SWING SYSTEM

Description

Planetary gear reduction driven by high torque axial piston motor, with oil disk brake. Swing parking brake resets within five seconds after swing pilot controls return to neutral.

Swing speed	12.94 rpm
Swing torque	36,793 N·m (27,137 lbf·ft)

HYDRAULIC SYSTEM

Main pump

Type	Two variable displacement piston pumps
Maximum flow	2 × 120 L/min (2 × 31.7 gal/min)

Pilot pump

Type	Gear pump
Maximum flow	19 L/min (5 gal/min)

Relief valve setting

Implement	34.3/37.3 MPa (4,975 / 5,410 psi)
Travel circuit	34.3 MPa (4,975 psi)
Slew circuit	25.5 MPa (3,698 psi)
Pilot circuit	3.9 MPa (566 psi)

Hydraulic cylinders

Boom Cylinder – Bore × Stroke	Φ105 × 990 mm (Φ4.1" × 3' 3")
Stick Cylinder – Bore × Stroke	Φ115 × 1,175 mm (Φ4.5" × 3' 10")
Bucket Cylinder – Bore × Stroke	Φ95 × 885 mm (Φ3.7" × 2' 11")

UNDERCARRIAGE

Track shoe each side	46
Link pitch	190 mm (7.5")
Shoe width, triple grouser	600 / 700 mm (24"/28")
Bottom rollers each side	7
Top rollers each side	1

ELECTRIC SYSTEM

System Voltage	24 V
Batteries	2 × 12 V
Alternator	24 V - 70 A
Start motor	24 V - 4.8 kW (24 V - 6.4 hp)

SERVICE CAPACITIES

Fuel tank	245 L (64.7 gal)
Engine oil	11 L (2.9 gal)
Final drive (each)	2.5 L (0.7 gal)
Swing drive	3 L (0.8 gal)
Cooling system	21 L (5.5 gal)
Hydraulic reservoir	160 L (42.3 gal)
Hydraulic system total	240 L (63.4 gal)
DEF tank	16.9 L (4.5 gal)

SOUND PERFORMANCE

Interior Sound Power Level (ISO 6396)	70 dB(A)
Exterior Sound Power Level (ISO 6395)	100 dB(A)

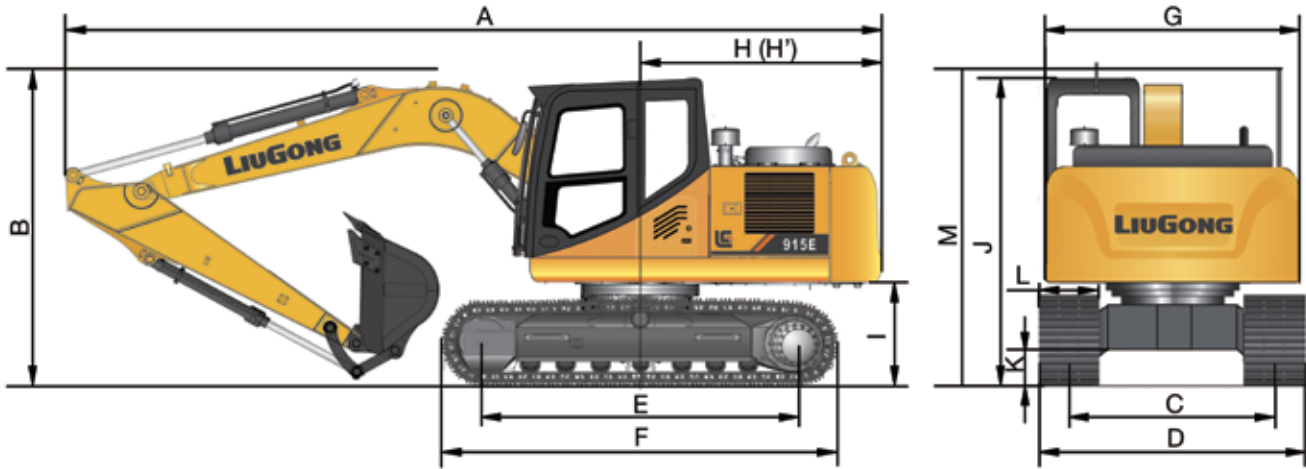

DIMENSIONS	
Boom	4,600 mm (15' 1")
Arm Options	2,500 mm (8' 2") 2,900 mm (9' 6")
A Shipping Length	7,750 mm (25' 5")
B Shipping Height – Top of Boom	3,055 mm (10')
C Track Gauge	1,990 mm (6' 6")
D Undercarriage Width – with 600 mm Shoes	2,590 mm (8' 6")
E Length to Center of Rollers	3,010 mm (9' 11")
F Track Length	3,746 mm (12' 3")
G Overall Width of Upper Structure	2,490 mm (8' 2")
H Tail Swing Radius	2,305 mm (7' 7")
I Counterweight Ground Clearance	960 mm (3' 2")
J Overall Height of Cab	3,055 mm (10')
K Min. Ground Clearance	430 mm (1' 5")
L Track Shoe Width	600 mm (24")

BOOM DIMENSIONS	
Boom	4,600 mm (15' 1")
Length	4,760 mm (15' 7")
Height	1,667 mm (5' 6")
Width	565 mm (with boom hinge pin 675 mm) / 1' 10" (with boom hinge pin 2' 3")
Weight	842 kg (1,857 lbs)

Cylinder, piping and pin included.
Boom cylinder pin excluded.

ARM DIMENSIONS		
Arm	2,500 mm (8' 2")	2,900 mm (9' 6")
Length	3,260 mm (10' 8")	3,659 mm (12')
Height	645 mm (2' 1")	704 mm (2' 4")
Width	370 mm (1' 3") (with hinge pin)	370 mm (1' 3") (with hinge pin)
Weight	555 kg (1,224 lbs)	605 kg (1,334 lbs)

Cylinder, linkage and pin included.

BUCKET SELECTION GUIDE

Bucket type	Capacity	Cutting width	Weight	Teeth pcs	4.6 m (15' 1") HD Boom	
					2.5 m (8' 2") Arm	2.9 m (9' 6") Arm
General purpose	0.77 m ³ (1.01 yd ³)	1,200 mm (3' 11")	670 kg (1,477 lbs)	6	B	NA
General purpose	0.36 m ³ (0.47 yd ³)	748 mm (2' 5")	390 kg (860 lbs)	5	NA	B

The recommendations are given as a guide only, based on typical operation conditions. Bucket capacity based on ISO 7451, heaped material with a 1:1 angle of repose.

- A 1,200 - 1,300 kg/m³ (2,023 - 2,191 lb/yd³): Coal, Caliche, Shale
- B 1,400 - 1,600 kg/m³ (2,360 - 2,697 lb/yd³): Wet earth and clay, limestone, sandstone
- C 1,700 - 1,800 kg/m³ (2,865 - 3,034 lb/yd³): Granite, wet sand, well blasted rock
- D 1,900 kg/m³ (3,203 lb/yd³): Wet mud, Iron ore
- NA. Not applicable

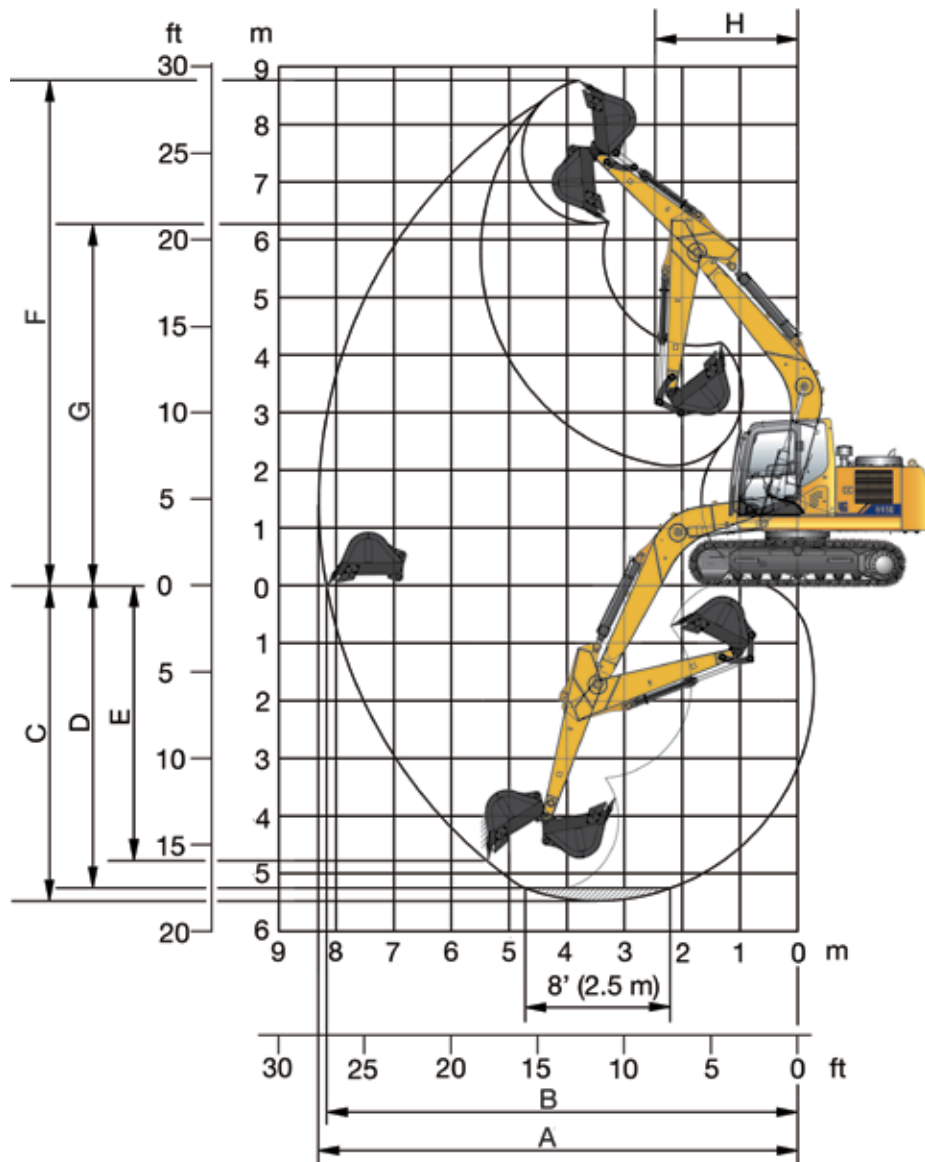

WORKING RANGE

Boom	4,600 mm (15'1")	
Arm Options	2,500 mm (8' 2")	2,900 mm (9' 6")
A. Max. Digging Reach	8,300 mm (27' 3")	8,600 mm (28' 3")
B. Max. Digging Reach on Ground	8,170 mm (26' 10")	8,490 mm (27' 10")
C. Max. Digging Depth	5,470 mm (17' 11")	5,870 mm (19' 3")
D. Max. Digging Depth, 2.44 m (8') Level	5,250 mm (17' 3")	5,670 mm (18' 7")
E. Max. Vertical Wall Digging Depth	4,770 mm (15' 8")	5,280 mm (17' 4")
F. Max. Cutting Height	8,760 mm (28' 9")	8,830 mm (29')
G. Max. Dumping Height	6,310 mm (20' 8")	6,400 mm (21')
H. Min. Front Swing Radius	2,305 mm (7' 7")	2,305 mm (7' 7")
Bucket Digging Force (ISO)	Normal	89.8 kN (20,188 lbf)
	Power Boost	96.9 kN (21,784 lbf)
Stick Digging Force (ISO)	Normal	64.9 kN (14,590 lbf)
	Power Boost	70 kN (15,737 lbf)
Bucket Capacity	0.77 m ³ (1.01 yd ³)	
Bucket Tip Radius	1,254 mm (4' 1")	

Lifting capacity at the arm end without bucket.
 For lifting capacity including bucket, weight of the bucket or the bucket with quick coupler must be deducted from the lifting capacities.
 Lifting capacities are based on the machine standing on a firm, uniform supporting surface.



Rating over - front (Cf)



Rating over - side (Cs)

- Do not attempt to lift or hold any load that is greater than these rated values at their specified load radius and height. Weight of all accessories must be deducted from the above lifting capacities.
- The rated loads are in compliance with ISO 10567 Hydraulic Excavator Lift Capacity Rating Standard. They do not exceed 87% of hydraulic lifting capacity or 75% tipping load.
- Ratings at bucket lift hook.

- Lifting capacities are based on machine standing on level, firm and uniform ground.
- *Indicates the load is limited by hydraulic capacity rather than tipping capacity.
- Operator should be fully acquainted with the Operator's and Maintenance Instructions before operating this machine and rules for the safe operation of equipment should be adhered to at all times.

LIFTING CAPACITY (METRIC)

915E with 600 mm shoes, 2,500 mm arm (Standard)

A: Load radius
 B: Load point height
 C: Lifting capacity
 Cf: Rating over front
 Cs: Rating over side

Conditions
 Boom length: 4,600 mm one-piece boom
 Arm length: 2,500 mm
 Bucket: None
 Shoes: 600 mm triple grouser
 Unit: kg

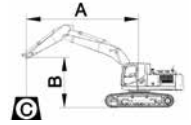

Blade: Down

A (Unit: m)

B (m)	1.5		3		4.5		6		MAX REACH		A (m)
	Cf	Cs	Cf	Cs	Cf	Cs	Cf	Cs	Cf	Cs	
6					*3,610	*3,610			*2,210	*2,210	5.4
4.5					*3,800	*3,800	*3,430	2,560	*1,940	*1,940	6.4
3			*6,150	*6,150	*4,530	3,800	*3,880	2,500	*2,070	2,020	6.9
1.5			*8,520	6,340	*5,420	3,560	*4,230	2,400	*2,630	1,940	7
0			*7,340	6,040	*5,980	3,400	*4,470	2,330	*2,450	1,940	6.9
-1.5	*5,270	*5,270	*8,830	6,020	*5,960	3,340	*4,320	2,310	*2,770	2,140	6.4
-3	*9,270	*9,270	*7,430	6,140	*5,120	3,390			*3,920	2,700	5.4

Blade: Up

A (Unit: m)

B (m)	1.5		3		4.5		6		MAX REACH		A (m)
	Cf	Cs	Cf	Cs	Cf	Cs	Cf	Cs	Cf	Cs	
6					*3,610	*3,610			*2,210	*2,210	5.4
4.5					*3,800	*3,800	*3,430	2,560	*1,940	*1,940	6.4
3			*6,150	*6,150	*4,530	3,800	3,810	2,500	*2,070	2,020	6.9
1.5			*8,520	6,340	*5,420	3,560	3,710	2,400	*2,630	1,940	7
0			*7,340	6,040	*5,980	3,400	3,630	2,330	*2,450	1,940	6.9
-1.5	*5,270	*5,270	*8,830	6,020	5,500	3,340	3,600	2,310	*2,770	2,140	6.4
-3	*9,270	*9,270	*7,430	6,140	*5,120	3,390			*3,920	2,700	5.4

915E with 700 mm shoes, 2,500 mm arm

A: Load radius
 B: Load point height
 C: Lifting capacity
 Cf: Rating over front
 Cs: Rating over side

Conditions
 Boom length: 4,600 mm one-piece boom
 Arm length: 2,500 mm
 Bucket: None
 Shoes: 700 mm triple grouser
 Unit: kg

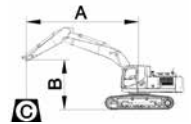

Blade: Down

A (Unit: m)

B (m)	1.5		3		4.5		6		MAX REACH		A (m)
	Cf	Cs	Cf	Cs	Cf	Cs	Cf	Cs	Cf	Cs	
6					*3,610	*3,610			*2,210	*2,210	5.4
4.5					*3,800	*3,800	*3,430	2,560	*1,940	*1,940	6.4
3			*6,150	*6,150	*4,530	3,800	*3,880	2,500	*2,070	2,020	6.9
1.5			*8,520	6,340	*5,420	3,560	*4,230	2,400	*2,630	1,940	7
0			*7,340	6,040	*5,980	3,400	*4,470	2,330	*2,450	1,940	6.9
-1.5	*5,270	*5,270	*8,830	6,020	*5,960	3,340	*4,320	2,310	*2,770	2,140	6.4
-3	*9,270	*9,270	*7,430	6,140	*5,120	3,390			*3,920	2,700	5.4

Blade: Up

A (Unit: m)

B (m)	1.5		3		4.5		6		MAX REACH		A (m)
	Cf	Cs	Cf	Cs	Cf	Cs	Cf	Cs	Cf	Cs	
6					*3,610	*3,610			*2,210	*2,210	5.4
4.5					*3,800	*3,800	*3,430	2,560	*1,940	*1,940	6.4
3			*6,150	*6,150	*4,530	3,800	3,810	2,500	*2,070	2,020	6.9
1.5			*8,520	6,340	*5,420	3,560	3,710	2,400	*2,630	1,940	7
0			*7,340	6,040	*5,980	3,400	3,630	2,330	*2,450	1,940	6.9
-1.5	*5,270	*5,270	*8,830	6,020	5,500	3,340	3,600	2,310	*2,770	2,140	6.4
-3	*9,270	*9,270	*7,430	6,140	*5,120	3,390			*3,920	2,700	5.4

Lifting capacity at the arm end without bucket.
 For lifting capacity including bucket, weight of the bucket or the bucket with quick coupler must be deducted from the lifting capacities.
 Lifting capacities are based on the machine standing on a firm, uniform supporting surface.



Rating over - front (Cf)



Rating over - side (Cs)

1. Do not attempt to lift or hold any load that is greater than these rated values at their specified load radius and height. Weight of all accessories must be deducted from the above lifting capacities.
2. The rated loads are in compliance with ISO 10567 Hydraulic Excavator Lift Capacity Rating Standard. They do not exceed 87% of hydraulic lifting capacity or 75% tipping load.
3. Ratings at bucket lift hook.

4. Lifting capacities are based on machine standing on level, firm and uniform ground.
5. *Indicates the load is limited by hydraulic capacity rather than tipping capacity.
6. Operator should be fully acquainted with the Operator's and Maintenance Instructions before operating this machine and rules for the safe operation of equipment should be adhered to at all times.

LIFTING CAPACITY (METRIC)

915E with 600 mm shoes, 2,900 mm arm (Standard)

A: Load radius
 B: Load point height
 C: Lifting capacity
 Cf: Rating over front
 Cs: Rating over side

Conditions

Boom length: 4,600 mm one-piece boom
 Arm length: 2,900 mm
 Bucket: None
 Shoes: 600 mm triple grouser
 Unit: kg

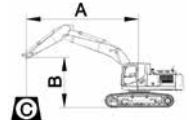

Blade: Down

A (Unit: m)

B (m)	1.5		3		4.5		6		MAX REACH		A (m)
	Cf	Cs	Cf	Cs	Cf	Cs	Cf	Cs	Cf	Cs	
6									*1,780	*1,780	5.9
4.5					*3,440	*3,440	*3,360	2,600	*1,710	*1,710	6.8
3			*5,430	*5,430	*4,190	3,870	*3,640	2,520	*1,660	*1,660	7.3
1.5			*7,940	6,520	*5,130	3,610	*4,040	2,410	*2,050	1,770	7.4
0			*7,880	6,070	*5,820	3,400	*4,350	2,310	*1,930	1,770	7.3
-1.5	*4,770	*4,770	*9,000	5,960	*5,950	3,300	*4,350	2,260	*2,380	1,930	6.8
-3	*7,980	*7,980	*7,870	6,020	*5,360	3,310			*3,140	2,340	5.9

Blade: Up

A (Unit: m)

B (m)	1.5		3		4.5		6		MAX REACH		A (m)
	Cf	Cs	Cf	Cs	Cf	Cs	Cf	Cs	Cf	Cs	
6									*1,780	*1,780	5.9
4.5					*3,440	*3,440	*3,360	2,600	*1,710	*1,710	6.8
3			*5,430	*5,430	*4,190	3,870	*3,640	2,520	*1,660	*1,660	7.3
1.5			*7,940	6,520	*5,130	3,610	3,700	2,410	*2,050	1,770	7.4
0			*7,880	6,070	5,500	3,400	3,600	2,310	*1,930	1,770	7.3
-1.5	*4,770	*4,770	*9,000	5,960	5,400	3,300	3,560	2,260	*2,380	1,930	6.8
-3	*7,980	*7,980	*7,870	6,020	*5,360	3,310			*3,140	2,340	5.9

915E with 700 mm Shoes, 2,900 mm Arm

A: Load radius
 B: Load point height
 C: Lifting capacity
 Cf: Rating over front
 Cs: Rating over side

Conditions

Boom length: 4,600 mm one-piece boom
 Arm length: 2,900 mm
 Bucket: None
 Shoes: 700 mm triple grouser
 Unit: kg

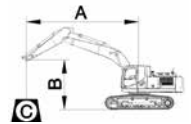

Blade: Down

A (Unit: m)

B (m)	1.5		3		4.5		6		MAX REACH		A (m)
	Cf	Cs	Cf	Cs	Cf	Cs	Cf	Cs	Cf	Cs	
6									*1,780	*1,780	5.9
4.5					*3,440	*3,440	*3,360	2,600	*1,710	*1,710	6.8
3			*5,430	*5,430	*4,190	3,870	*3,640	2,520	*1,660	*1,660	7.3
1.5			*7,940	6,520	*5,130	3,610	*4,040	2,410	*2,050	1,770	7.4
0			*7,880	6,070	*5,820	3,400	*4,350	2,310	*1,930	1,770	7.3
-1.5	*4,770	*4,770	*9,000	5,960	*5,950	3,300	*4,350	2,260	*2,380	1,930	6.8
-3	*7,980	*7,980	*7,870	6,020	*5,360	3,310			*3,140	2,340	5.9

Blade: Up

A (Unit: m)

B (m)	1.5		3		4.5		6		MAX REACH		A (m)
	Cf	Cs	Cf	Cs	Cf	Cs	Cf	Cs	Cf	Cs	
6									*1,780	*1,780	5.9
4.5					*3,440	*3,440	*3,360	2,600	*1,710	*1,710	6.8
3			*5,430	*5,430	*4,190	3,870	*3,640	2,520	*1,660	*1,660	7.3
1.5			*7,940	6,520	*5,130	3,610	3,700	2,410	*2,050	1,770	7.4
0			*7,880	6,070	5,500	3,400	3,600	2,310	*1,930	1,770	7.3
-1.5	*4,770	*4,770	*9,000	5,960	5,400	3,300	3,560	2,260	*2,380	1,930	6.8
-3	*7,980	*7,980	*7,870	6,020	*5,360	3,310			*3,140	2,340	5.9

Lifting capacity at the arm end without bucket.
 For lifting capacity including bucket, weight of the bucket or the bucket with quick coupler must be deducted from the lifting capacities.
 Lifting capacities are based on the machine standing on a firm, uniform supporting surface.



Rating over - front (Cf)



Rating over - side (Cs)

1. Do not attempt to lift or hold any load that is greater than these rated values at their specified load radius and height. Weight of all accessories must be deducted from the above lifting capacities.
2. The loads are in compliance with ISO 10567 Hydraulic Excavator Lift Capacity Rating Standard. They do not exceed 87% of hydraulic lifting capacity or 75% tipping load.
3. Ratings at bucket lift hook.

4. Lifting capacities are based on machine standing on level, firm and uniform ground.
5. *Indicates the load is limited by hydraulic capacity rather than tipping capacity.
6. Operator should be fully acquainted with the Operator's and Maintenance Instructions before operating this machine and rules for the safe operation of equipment should be adhered to at all times.

LIFTING CAPACITY (IMPERIAL)

915E with 24" shoes, 8' 2" arm (Standard)

A: Load radius
 B: Load point height
 C: Lifting capacity
 Cf: Rating over front
 Cs: Rating over side

Conditions

Boom length: 15' 1" one-piece boom
 Arm length: 8' 2"
 Bucket: None
 Shoes: 24" triple grouser
 Unit: lbs

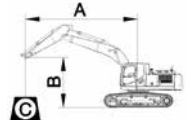

Blade: Down

A (Unit ft)

B (ft)	5		10		15		20		MAX REACH		A (ft)
	Cf	Cs	Cf	Cs	Cf	Cs	Cf	Cs	Cf	Cs	
20					*7,950	*7,950			*4,870	*4,870	17.7
15					*8,370	*8,370	*7,560	5,640	*4,270	*4,270	21.0
10			*13,550	*13,550	*9,980	8,370	*8,550	5,510	*4,560	4,450	22.6
5			*18,780	13,970	*11,940	7,840	*9,320	5,290	*5,790	4,270	23.0
0			*16,180	13,310	*13,180	7,490	*9,850	5,130	*5,400	4,270	22.6
- 5	*11,610	*11,610	*19,460	13,270	*13,130	7,360	*9,520	5,090	*6,100	4,710	21.0
- 10	*20,430	*20,430	*16,380	13,530	*11,280	7,470			*8,640	5,950	17.7

Blade: Up

A (Unit ft)

B (ft)	5		10		15		20		MAX REACH		A (ft)
	Cf	Cs	Cf	Cs	Cf	Cs	Cf	Cs	Cf	Cs	
20					*7,950	*7,950			*4,870	*4,870	17.7
15					*8,370	*8,370	*7,560	5,640	*4,270	*4,270	21.0
10			*13,550	*13,550	*9,980	8,370	8,390	5,510	*4,560	4,450	22.6
5			*18,780	13,970	*11,940	7,840	8,170	5,290	*5,790	4,270	23.0
0			*16,180	13,310	*13,180	7,490	8,000	5,130	*5,400	4,270	22.6
- 5	*11,610	*11,610	*19,460	13,270	*12,120	7,360	7,930	5,090	*6,100	4,710	21.0
- 10	*20,430	*20,430	*16,380	13,530	*11,280	7,470			*8,640	5,950	17.7

915E with 28" Shoes, 8'2" Arm (Standard)

A: Load radius
 B: Load point height
 C: Lifting capacity
 Cf: Rating over front
 Cs: Rating over side

Conditions

Boom length: 15'1" one-piece boom
 Arm length: 8'2"
 Bucket: None
 Shoes: 28" triple grouser
 Unit: lbs

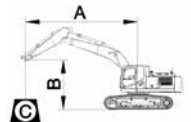

Blade: Down

A (Unit ft)

B (ft)	5		10		15		20		MAX REACH		A (ft)
	Cf	Cs	Cf	Cs	Cf	Cs	Cf	Cs	Cf	Cs	
20					*7,950	*7,950			*4,870	*4,870	17.7
15					*8,370	*8,370	*7,560	5,640	*4,270	*4,270	21.0
10			*13,550	*13,550	*9,980	8,370	*8,550	5,510	*4,560	4,450	22.6
5			*18,780	13,970	*11,940	7,840	*9,320	5,290	*5,790	4,270	23.0
0			*16,180	13,310	*13,180	7,490	*9,850	5,130	*5,400	4,270	22.6
- 5	*11,610	*11,610	*19,460	13,270	*13,130	7,360	*9,520	5,090	*6,100	4,710	21.0
- 10	*20,430	*20,430	*16,380	13,530	*11,280	7,470			*8,640	5,950	17.7

Blade: Up

A (Unit ft)

B (ft)	5		10		15		20		MAX REACH		A (ft)
	Cf	Cs	Cf	Cs	Cf	Cs	Cf	Cs	Cf	Cs	
20					*7,950	*7,950			*4,870	*4,870	17.7
15					*8,370	*8,370	*7,560	5,640	*4,270	*4,270	21.0
10			*13,550	*13,550	*9,980	8,370	8,390	5,510	*4,560	4,450	22.6
5			*18,780	13,970	*11,940	7,840	8,170	5,290	*5,790	4,270	23.0
0			*16,180	13,310	*13,180	7,490	8,000	5,130	*5,400	4,270	22.6
- 5	*11,610	*11,610	*19,460	13,270	*12,120	7,360	7,930	5,090	*6,100	4,710	21.0
- 10	*20,430	*20,430	*16,380	13,530	*11,280	7,470			*8,640	5,950	17.7

Lifting capacity at the arm end without bucket.
 For lifting capacity including bucket, weight of the bucket or the bucket with quick coupler must be deducted from the lifting capacities.
 Lifting capacities are based on the machine standing on a firm, uniform supporting surface.



Rating over - front (Cf)



Rating over - side (Cs)

1. Do not attempt to lift or hold any load that is greater than these rated values at their specified load radius and height. Weight of all accessories must be deducted from the above lifting capacities.
2. The rated loads are in compliance with ISO 10567 Hydraulic Excavator Lift Capacity Rating Standard. They do not exceed 87% of hydraulic lifting capacity or 75% tipping load.
3. Ratings at bucket lift hook.

4. Lifting capacities are based on machine standing on level, firm and uniform ground.
5. *Indicates the load is limited by hydraulic capacity rather than tipping capacity.
6. Operator should be fully acquainted with the Operator's and Maintenance Instructions before operating this machine and rules for the safe operation of equipment should be adhered to at all times.

LIFTING CAPACITY (IMPERIAL)

915E with 24" Shoes, 9'6" Arm

A: Load radius
 B: Load point height
 C: Lifting capacity
 Cf: Rating over front
 Cs: Rating over side

Conditions

Boom length: 15'1" one-piece boom
 Arm length: 9'6"
 Bucket: None
 Shoes: 24" triple grouser
 Unit: lbs

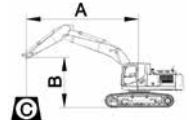

Blade: Down

A (Unit ft)

B (ft)	5		10		15		20		MAX REACH		A (ft)
	Cf	Cs	Cf	Cs	Cf	Cs	Cf	Cs	Cf	Cs	
20									*3,920	*3,920	19.4
15					*7,580	*7,580	*7,400	5,730	*3,760	*3,760	22.3
10			*11,970	*11,970	*9,230	8,530	*8,020	5,550	*3,650	3,650	24.0
5			*17,500	14,370	*11,300	7,950	*8,900	5,310	*4,510	3,900	24.3
0			*17,370	13,380	*12,830	7,490	*9,590	5,090	*4,250	3,900	24.0
- 5	*10,510	*10,510	*19,840	13,130	*13,110	7,270	*9,590	4,980	*5,240	4,250	22.3
- 10	*17,590	*17,590	*17,350	13,270	*11,810	7,290			*6,920	5,150	19.4

Blade: Up

A (Unit ft)

B (ft)	5		10		15		20		MAX REACH		A (ft)
	Cf	Cs	Cf	Cs	Cf	Cs	Cf	Cs	Cf	Cs	
20									*3,920	*3,920	19.4
15					*7,580	*7,580	*7,400	5,730	*3,760	*3,760	22.3
10			*11,970	*11,970	*9,230	8,530	*8,020	5,550	*3,650	3,650	24.0
5			*17,500	14,370	*11,300	7,950	8,150	5,310	*4,510	3,900	24.3
0			*17,370	13,380	12,120	7,490	7,930	5,090	*4,250	3,900	24.0
- 5	*10,510	*10,510	*19,840	13,130	11,900	7,270	7,840	4,980	*5,240	4,250	22.3
- 10	*17,590	*17,590	*17,350	13,270	*11,810	7,290			*6,920	5,150	19.4

915E with 28" Shoes, 9'6" Arm

A: Load radius
 B: Load point height
 C: Lifting capacity
 Cf: Rating over front
 Cs: Rating over side

Conditions

Boom length: 15'1" one-piece boom
 Arm length: 9'6"
 Bucket: None
 Shoes: 28" triple grouser
 Unit: lbs

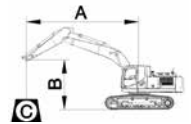

Blade: Down

A (Unit ft)

B (ft)	5		10		15		20		MAX REACH		A (ft)
	Cf	Cs	Cf	Cs	Cf	Cs	Cf	Cs	Cf	Cs	
20									*3,920	*3,920	19.4
15					*7,580	*7,580	*7,400	5,730	*3,760	*3,760	22.3
10			*11,970	*11,970	*9,230	8,530	*8,020	5,550	*3,650	3,650	24.0
5			*17,500	14,370	*11,300	7,950	*8,900	5,310	*4,510	3,900	24.3
0			*17,370	13,380	*12,830	7,490	*9,590	5,090	*4,250	3,900	24.0
- 5	*10,510	*10,510	*19,840	13,130	*13,110	7,270	*9,590	4,980	*5,240	4,250	22.3
- 10	*17,590	*17,590	*17,350	13,270	*11,810	7,290			*6,920	5,150	19.4

Blade: Up

A (Unit ft)

B (ft)	5		10		15		20		MAX REACH		A (ft)
	Cf	Cs	Cf	Cs	Cf	Cs	Cf	Cs	Cf	Cs	
20									*3,920	*3,920	19.4
15					*7,580	*7,580	*7,400	5,730	*3,760	*3,760	22.3
10			*11,970	*11,970	*9,230	8,530	*8,020	5,550	*3,650	3,650	24.0
5			*17,500	14,370	*11,300	7,950	8,150	5,310	*4,510	3,900	24.3
0			*17,370	13,380	12,120	7,490	7,930	5,090	*4,250	3,900	24.0
- 5	*10,510	*10,510	*19,840	13,130	11,900	7,270	7,840	4,980	*5,240	4,250	22.3
- 10	*17,590	*17,590	*17,350	13,270	*11,810	7,290			*6,920	5,150	19.4

STANDARD EQUIPMENT

ENGINE SYSTEM

- Cummins diesel engine, turbocharged, inline 4-cylinder, 4 stroke, water cooled
- Auto-idle speed control
- Air filter with pre-cleaner
- Engine oil filter
- Pre-filter with water separator
- Radiator, oil cooler and intercooler
- IPC (Intelligent Power Control) System
- Engine overheating prevention system

DRIVETRAIN

- Hydraulic motor, one-piece two-gear piston and reducer
- 2-speed travel system with automatic shift

SWING SYSTEM

- High-torque piston swing motor with integral spring set and automatic hydraulic release swing brake

HYDRAULIC SYSTEM

- Main pump: two variable displacement piston pumps, ready for PTO
- Pilot pump: gear
- Cylinders: boom, stick, bucket
- Power boost function
- Boom and arm regeneration circuits
- Pilot oil filter
- Load holding valve
- Pilot control shut-off lever
- Hose burst safety valves, prevention of boom or arm supply dropped when the lines split (2 mounted on boom cylinders, 1 on arm cylinder)
- 6-working mode selection system: Power, Economy, Fine, Lifting, Breaker, Attachment

DIGGING EQUIPMENT

- 4,600 mm (15' 1") boom
- 2,500 mm (8' 2") arm

OPERATOR STATION

- Pressurized and sealed cab with all-around visibility, large roof window with slide sliding sun visor, front window wiper and removable lower window
- Roll-Over Protective System (ROPS)
- Mechanical suspension seat
- Skylight rooftop
- Air conditioner, heater, defroster
- Swing parking brake
- AM/FM radio with MP3 audio jack
- Glass-breaking hammer
- Ashtray, cigarette lighter
- Cup holder
- Floor mat
- Storage box
- Front glass lower guard
- Fire extinguisher
- Rear view mirrors
- One key for all locks
- Rear view camera 5,7" monitor

INSTRUMENTATION

- Color LCD monitor with alarms, filter/fluid change, fuel rate, water temperature, work mode, fault code, working hour, etc.
- Fuel gauge
- Hydraulic oil level gauge

ELECTRICAL

- Alternator 70 A
- Dual batteries 12 V
- Working lights, 1 frame mounted, 2 boom mounted
- Starting, 24 V
- Travel alarm
- Rotating beacon light

UNDERCARRIAGE

- 600 mm (24") track-shoes with triple grousers
- 1 piece track - guard (each side)
- Towing eye on base frame

GUARDS

- Belly guard and 2 mm platform bottom plate

OTHER STANDARD EQUIPMENT

- 2,300 kg (5,071 lbs) counterweight
- Maintenance tool kit
- Maintenance parts package

OTHER STANDARD EQUIPMENT

- Less bucket includes bucket pins

OPTIONAL EQUIPMENT

ENGINE SYSTEM

- Electrical fuel refilling pump

HYDRAULIC SYSTEM

- Control pattern change valve
- Hydraulic lines: Breaker & shear
- Slope & rotator
- Grapple
- Oil drain line
- Quick coupler
- Hydraulic quick coupler
- Overloading valve
- Cushion valve

OPERATOR STATION

- Power outlet 24 V to 12 V converter
- 4 LED cab top lights
- Working lights on cab (2 on top-front cab)
- Air suspension seat
- Control joysticks with 2 switch & 1 proportional
- Safety net for front window
- Rain visor
- Operation protection guard (included cab front and top guard, bar)
- Operation protection screen (on cab front, net)
- Operation protection screen (front-lower)

UPPER STRUCTURE

- Upper frame protection (wire)
- Belly guard and 8 mm thickness platform bottom plate
- Bucket cylinder guard

UNDERCARRIAGE

- 700 mm (28") track-shoes with triple grousers

DIGGING EQUIPMENT

- Arm: 2,900 mm (9' 6")
- 0.36 m³ (0.47 yd³) bucket (SAE, heaped)

OTHER EQUIPMENT

- Dozer blade



Guangxi LiuGong Machinery Co., Ltd.
No. 1 Liutai Road, Liuzhou, Guangxi 545007, PR China
T: +86 772 388 6124 E: overseas@liugong.com
www.liugong.com

Like and follow us:



LG-PB-915E-24-21022019-ENG

The LiuGong series of logos herein, including but not limited to word marks, device marks, letter of alphabet marks and combination marks, as the registered trademarks of Guangxi LiuGong Group Co., Ltd. are used by Guangxi LiuGong Machinery Co., Ltd. with legal permission, and shall not be used without permission. Specifications and designs are subject to change without notice. Illustrations and pictures may include optional equipment and may not include all standard equipment. Equipment and options varies by regional availability.